

Data Sheet

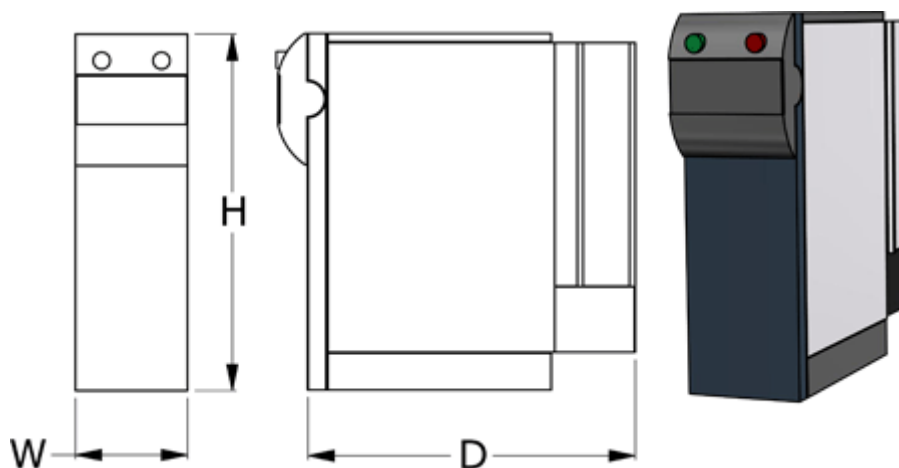

Article number: 1080201051000
Description: Servocontroller ACU201-05-FA
0,55 kW 3A 1x230V IP20

Measures



D = 175
H = 190
W = 60
Weight = 1.2